

# Technologically Advanced Method For Water & Fluid Management

Triangular Wave Technologies Inc. Patented Microprocessor Deposit Control System

## Control Lime Scale and Bio-fouling in all Water-Fed Appliances...

TWT water treatment systems are engineered for exceptional performance. These systems are ideally suited for Homes, Offices, Factories, Farms, Medical/ Dental & Laboratory Environments, Restaurants, Schools, Coffee & Tea Dispensers, Ice Making Machines, Spas, Beverage Dispensing Machines, Bottleless Water Coolers, Tavern Draft Taps, Aquariums, Espresso Machines, and anywhere the need for cleaner water to use and drink is required.

### How the Triangular Wave Systems Control Lime Scale, and Biological Deposits.

Scale and biological deposits form when these elements "stick" to the surfaces of tubes / pipes, water tanks, heat exchangers, plumbing fixtures and other water-fed equipment. The Triangular Wave Deposit Controller charges the particles in the water so that they will not stick together or stick to any surfaces.

### Simply Said...

The TWT® Deposit Control Technology gives you the total effect of soft water without the negative consequences, and clear up the deposits you already have!

### Advanced Technology Means...

- Provide the effects of softened water, neutralizes calcium hardness effects in the water
- Reduces onsite service calls
- Prevents scale & slime buildup on tubes / piping and equipment surfaces
- Reduces Corrosion
- Stops Lime Scale Build-Up
- Controls Algae and Bacteria
- Uses no salts or other chemicals
- Reduces Spotting on Ice
- Service and MAINTENANCE-FREE!
- Improves efficiency of all water-fed appliances and extends their life cycle
- Quickly pays for itself and continues saving (energy, water and maintenance)
- Descales the entire system over time
- Extends Life of Heating Elements
- Designed for safety: The output is safe to both personnel and equipment. There is NO ELECTRICAL CONTACT WITH THE PIPE

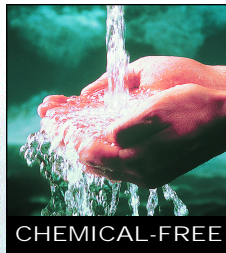

FIELD TESTED AND PROVEN EFFECTIVE

REDUCES MAINTENANCE AND ONSITE SERVICE COSTS

### Patented Triangular Wave Deposit Control System

The *Triangular Wave Deposit Control System* is an advanced method for controlling scale and bio-fouling. The patented *Triangular Wave System* includes a factory-wrapped and protected TWT Reaction Chamber (solenoid coil) that connects to the TWT Deposit Controller and power supply, which constantly changes the polarity, frequency and amplitude of the current being sent to the solenoid. This forms an ever-changing electromagnetic field, which induces a constantly changing voltage that treats the particles in the water 100% of the time.

### All the benefits of SOFT WATER WITHOUT THE SALT!

- Reaction chamber compatible with all types of pipes & tubes
- Easy to follow installation instructions
- Takes up minimal space and plugs into a standard 110/120 vac outlet. Other current source and battery powered systems available upon request
- GUARANTEED
- 5 YEAR WARRANTY
- Uses only \$10.00 to \$14.00 of electricity per year
- STOPS LIME SCALE BUILD UP

### TWT® Chemical-Free Fluid Management System Provides...

- **NEW EQUIPMENT:** TWT provides new equipment with the ability to enhance the product benefit an features.
- **EXISTING EQUIPMENT:** Retrofit existing equipment to improve its operating efficiency and life cycle.
- **ENHANCE PRODUCT LINE:** Enter new markets and broaden customer satisfaction.

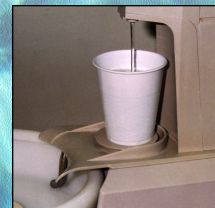



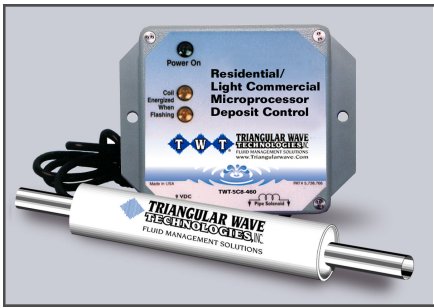

**System: TWT-5C8-460FGRC**  
(small water-fed appliances)  
Deposit Controller / Reaction Chamber for  
Tubes & Pipes 1/2" or less



**System: TWT-5C8-472FGRC**  
Residential/Commercial Deposit Control  
System with PVC Reaction Chamber for  
Tubes & Pipes 1" or less



**System: TWT-5C8-473APVC**  
(larger water-fed appliances)  
Deposit Controller / PVC Reaction  
Chamber for Tubes & Pipes upto 1 inch



**System: TWT-5C8-473ST**  
(larger water-fed appliances)  
Deposit Controller / Stainless Steel  
Reaction Chamber for Tubes & Pipes upto 1 inch

## Microprocessor Driven Factory Wrapped Wire Coil Reaction Chambers

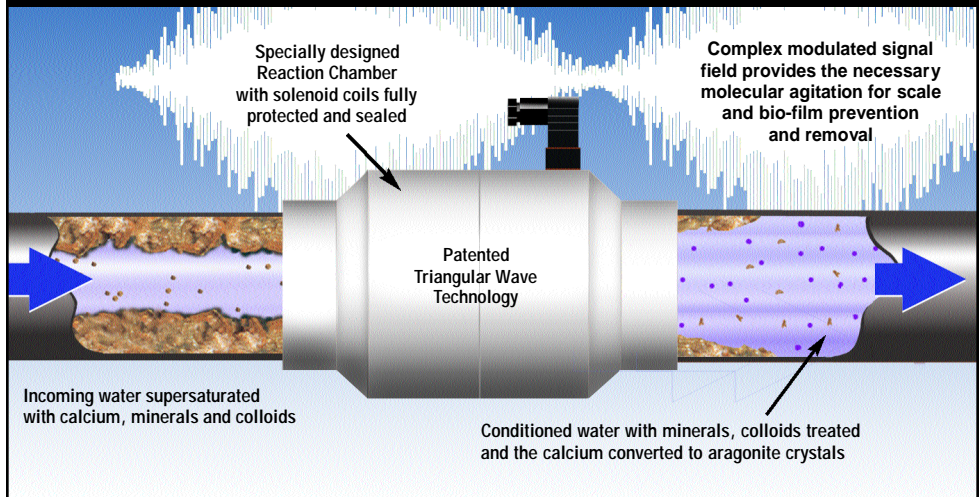

Using modern integrated circuitry and signal processing techniques, the patented TWT Deposit Control Technology works by producing a complex frequency-modulated waveform. This creates a deionizing effect, induced by physical means, which increases the solubility of the minerals, and colloids in the liquid and changes the shape, size and texture of the calcium carbonate crystals. By this reaction, the minerals, colloids and crystals lose their adhesive properties and remain in suspension in the liquid. Pre-existing scale is taken back into solution and removed in the same way. The effects are immediate and long lasting down stream.

*In effect, a clean, corrosion-free delivery system is restored and maintained in an environmentally safe and chemical-free manner. The result is clean pipes and tubing with no biofilm and reduced bacterial contamination.*

## Beverage Vending Equipment

### APPLICATION:

Coffee, Tea, Hot Chocolate Dispensers, Commercial, Vending, and other large capacity units

### PROBLEM:

Coffee and Tea Dispensers and the water lines that feed them suffer from build-up of lime scale and bio-film. Not only does this lead to aesthetically unpleasant bitter tastes and odors in the beverage, the scale and bio-film become a "home" for bacteria that transfer to the beverage, the dispenser works less efficiently (costs more to run in electricity and water, and more to maintain), and has a shorter overall working life.

*How can the TWT Deposit Control System help?*

When installed as directed by TWT, the Deposit Controller can help optimize equipment operation and will:

- Reduce and prevent scale, opening up the water flow
- Reduce bio-film as well as contaminant growth
- Improve beverage taste and appearance - lessen bitterness, oily residue, and odor
- Reduce filter clogs and nozzle dispenser clogs, by improving the effectiveness of the filters
- Improve coffee/tea to "per serving" ratio, allowing for better tasting beverages
- Reduce brewing time
- Increase heating efficiency of coils, hot water tanks and other associated components used for brewing and serving by keeping them all cleaner
- Reduce the need for service calls - reduce labor costs
- Reduce equipment downtime, increase vends and availability of beverages
- Reduce electricity costs by lowering kilowatt usage through increased heat transfer efficiency
- Increase the life cycle of the equipment
- Provide responsible, chemical-free treatment



# Beverage Vending Equipment

**APPLICATION:** *Bottleless Water Coolers*

---

**PROBLEM:**

*Bottleless water coolers and the water that they dispense harbor bio-film contamination and the resulting bacteria that form. How can the TWT Deposit Control System help?*

When installed as directed by TWT, the Deposit Controller can help optimize equipment operation and will:

- Reduce and prevent scale, opening up the water flow
- Reduce bio-film and contaminants and therefore reduce unpleasant taste and odor
- Reduce filter clogs and nozzle dispenser clogs, and better maintain the capillary lines by improving the effectiveness of your filters
- Increase the rate of water production
- Increase the accuracy and efficiency of the unit's controls and sensors, because they are cleaner
- Reduce changes of elements and repair frequency, because units are operating more efficiently
- Reduce the need for service calls by service personnel - reduce labor costs
- Reduce electricity costs by lowering kilowatt usage through increased efficiency
- Increase the useful life of the equipment
- Provide responsible, chemical-free treatment



**APPLICATION:** *Ice Making Machines*

---

**PROBLEM:**

*Scale, particulates, and contaminants can cause cubes to be cloudy, contain visible particles, and suffer from aesthetic problems, including unpleasant taste and odor*

*How can the TWT Deposit Control System help?*

When installed as directed by TWT, the Deposit Controller can help optimize equipment operation and will:

- Reduce and prevent scale, opening up the water flow
- Reduce filter clogs by keeping colloidal particles suspended in the water and away from the filter surface
- Reduce bio-film and contaminants, and therefore reduce unpleasant taste and odor
- Produce clearer, "better looking" cubes, improved customer satisfaction
- Allow cubes and crushed to be dispensed more easily less scale means less "drag" during ice release
- Provide quieter, less noisy production due to reduced strain on equipment
- Provide cleaner coils, and therefore better heat transfer
- Increase ice production/kilowatts spent ratio
- Reduce repair frequency and downtime, because units are operating more efficiently
- Reduce the need for service calls by service personnel - reduce labor costs
- Reduce electricity costs by lowering kilowatt usage through increased efficiency
- Increase the useful life of the equipment
- Provide responsible, chemical-free treatment

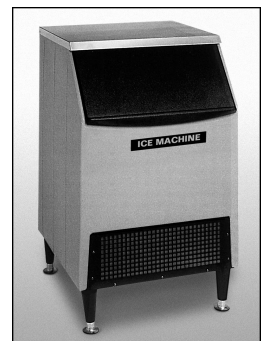

**APPLICATION:** *Soup Vending*

---

**PROBLEM:**

*The mechanisms for all liquid product vending machines follow the same principles - water is input, dry metered mix is added, water is jetted into mix, product brews or cooks, and serves at the outlet. This type of equipment all have heat exchange coils, water lines, volume meters, nozzles, and level controls that must be kept clean and free of scale and biofilm deposits. Not only does this lead to aesthetically unpleasant bitter tastes and odors in the beverage, the scale and bio-film may become a "home" for bacteria that transfer to the beverage, the dispenser works less efficiently (costs more to run in coffee/tea/hot chocolate, electricity, water, and costs more to maintain), and has a shorter overall working life.*

*How can the TWT Deposit Control System help?*

When installed as directed by TWT, the Deposit Controller can help optimize equipment operation and will:

- Reduce and prevent scale, opening up the water flow
- Reduce bio-film as well as contaminant growth.
- Improve beverage taste and appearance lessen bitterness, oily residue, and odor
- Reduce filter clogs and nozzle dispenser clogs, by improving the effectiveness of the filters
- Improve mix to "per serving" ratio, allowing for better taste
- Reduce cooking time
- Increase heating efficiency of coils, hot water tanks, and other associated components and equipment used for brewing and serving by keeping them all cleaner
- Reduce the need for service calls by service personnel - reduce labor costs
- Reduce electricity costs by lowering kilowatt usage through increased heat transfer efficiency
- Increase the useful life of the equipment
- Provide responsible, chemical-free treatment

# Beverage Vending Equipment

**APPLICATION:** Espresso Machines

**PROBLEM:**

Espresso machines and the water lines that feed them suffer from build-up of scale. The machines have rapid steam-fed brewers that are very prone to scale buildup. This may lead to aesthetically unpleasant, bitter tastes and odors in the beverage. In addition, the espresso machine works less efficiently (costs more to run in coffee, electricity, water, and costs more to maintain), and has a shorter overall working life.

How can the TWT Deposit Control System help?

When installed as directed by TWT, the Deposit Controller can help optimize equipment operation and will:

- Reduce and prevent scale, opening up the water flow
- Improve beverage taste and appearance lessen bitterness, oily residue, and odor
- Reduce filter clogs and nozzle dispenser clogs, by improving the effectiveness of the filters
- Improve coffee to “per serving” ratio, allowing better taste
- Increase heating efficiency of boilers, hot water tanks, and other associated components and equipment used for brewing and serving by keeping them all cleaner
- Reduce the need for service calls by service personnel - reduce labor costs
- Reduce electricity costs by lowering kilowatt usage through increased heat transfer efficiency
- Increase the useful life of the equipment
- Provide responsible, chemical-free treatment

**APPLICATION:** Soda Dispensing Equipment

**PROBLEM:**

Soda dispensing equipment is historically very high maintenance - the meters, jets, and nozzles scale quickly and cause inefficiencies in many ways, requiring many maintenance hours per week for proper operation, and causing equipment down time. Since the use of salt and chemical methods to soften water and remove scale will affect the taste of the soda syrup dispensed, the machines cannot use traditionally softened water, or traditional chemical scale treatment methods. Manual maintenance has been the answer to date, but it is inconsistent and costly in terms of labor, supplies, and downtime.

How can the TWT Deposit Control System help?

When installed as directed by TWT, the Deposit Controller can help optimize equipment operation and will:

- Reduce scale and clogging
- Reduce unpleasant taste or odor
- Make bottle replacement easier because fittings don't scale
- Keep nozzles, jets and valves clean
- Keep meters functioning accurately, reducing syrup waste
- Reduce the maintenance cycle, saving time and lowering labor costs
- Improve equipment reliability
- Extend useful life of equipment
- Provide responsible, chemical-free treatment



AT HOME



IN LABORATORY, MEDICAL & DENTAL ENVIRONMENTS



ON THE FARM



IN RESTAURANTS

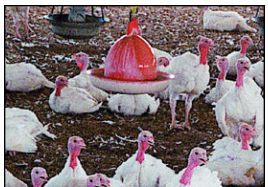

ON THE FARM

• TWT Deposit Control Systems work to protect other treatment technologies as well, including ozone, ultraviolet, and other filtration systems, keeping them clean and enhancing their operation. In this way, their full treatment benefits are realized, with reduced maintenance requirements.

Consider using TWT Deposit Control Systems in conjunction with any fluid treatment systems as a complementary technology. For further details on how you can leverage the TWT Deposit Control benefits, please contact us.

Note:  
Review instructions & application guidelines for TWT Deposit Control Systems before installation, upgrades may be appropriate and necessary.  
If your application is not listed here, please contact TWT



# TWT® Application & Installation Guideline for Water-Fed Appliances

## Our suggested considerations for optimal installation of the TWT Deposit Control System:

1. Cut water line and insert TWT Reaction Chamber using John Guest connectors. Clamp as illustrated.
2. Attach power supply to back of machine or adjacent to water-fed appliance in safe location.
3. Attach wire leads from Reaction Chamber to terminals on Deposit Controller.
4. Plug transformer/power supply into a standard 110 VAC outlet.

The Deposit Control System will provide the means to keep deposits (calcium, lime, etc.) in solution for extended periods, if not disturbed. The ability of the fluid to retain the deposits in solution is reduced by fluid disturbances (e.g., pressure changes) and high temperature conditions (flashing, boiling, etc.). In Automatic Fill Systems, a Fill Solenoid Valve will be used to control the fluid level in the fill system. Where a large pressure change takes place immediately downstream of the solenoid valve, **TWT recommends that the Reaction Chamber and/or the on-site wrap be located downstream from the solenoid valve to avoid this pressure change point.**

When water boils and is evaporated, the calcium and other dissolved solids remain and form deposits. These deposits will be softer and more easily removed when treated by the TWT system. If a heating system can be operated without boiling/flashing on the surface of the heating element, a significant reduction in deposits will be obtained. As the fluid temperature is lowered from boiling, the ability of the TWT-treated water to hold the minerals in solution increases.

**Note: Deposit Controller/Reaction Chamber should be installed on water feed line after any filter and/or solenoid valve system. Install Reaction Chamber on water feed line midway between solenoid valve and water tank.**

The copper signal enhancer is a passive signal / impedance matching circuit. This device provides a power boost to the conditioning signal in copper pipes.

TWT-5C8-473 Deposit Controller & Onsite Wrap for Tube and Pipe 1" or Less in diameter

TWT-CSE-0227 Copper Pipe Signal Enhancer for Tube & Pipe 2" or Less

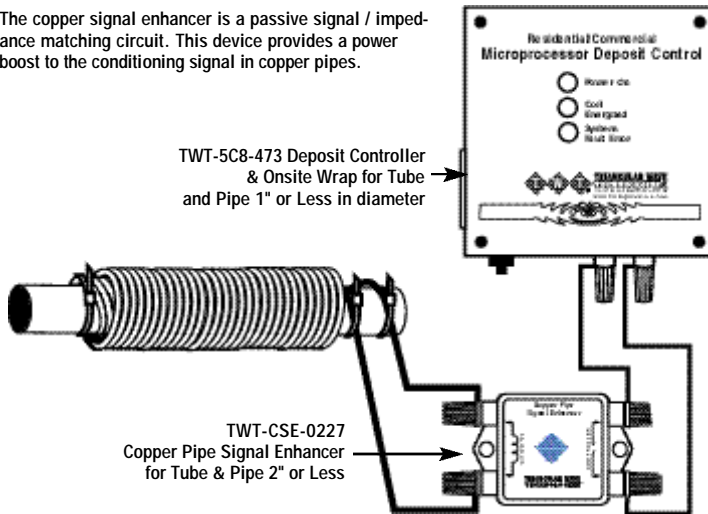

**Copper pipes, although acceptable, are one of the more difficult of materials to work with. To overcome this difficulty...**

Triangular Wave Technologies has designed its Copper Pipe Signal Enhancer. This unit is placed between the controller and the copper pipe solenoid. The function of the signal enhancer is to provide a proper impedance match and to ensure maximum energy transfer between the controller and the solenoid, which ensures enhanced treatment of the fluid. The Copper Pipe Signal Enhancer must be used in all copper pipe applications to maximize the performance, and provide a boost to your application.

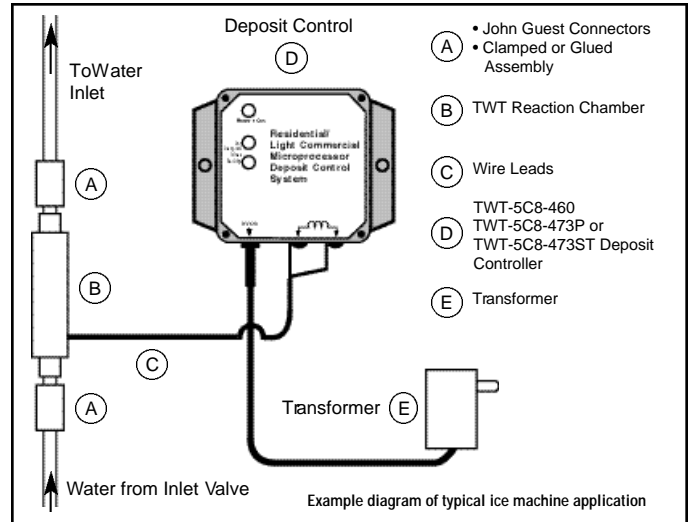

*When the TWT systems are properly installed, the effects of the Triangular Wave Technology Treatment Last Downstream*

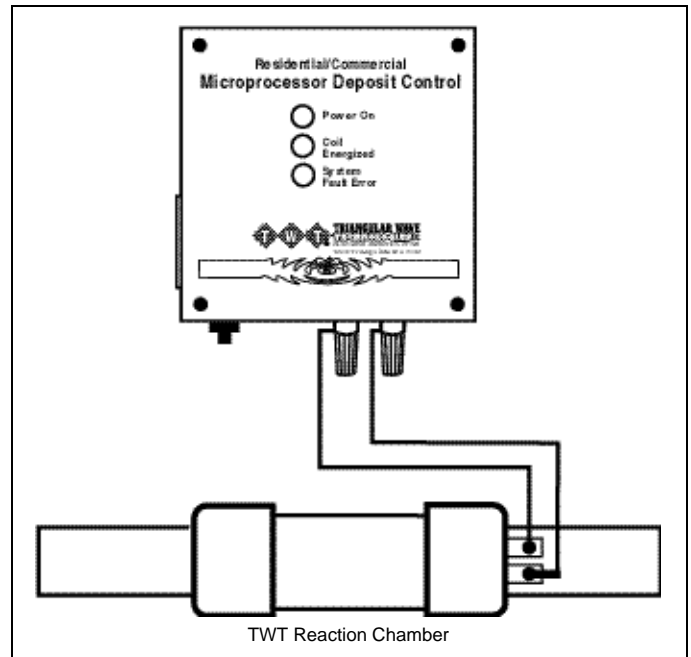

To use in conjunction with the TWT Deposit Control Systems when required, Triangular Wave Technologies, Inc. has developed a line of factory-wrapped wire coil Reaction Chambers to address magnetic pipe environments. Typically, wire coil cannot be installed on any magnetic pipe, such as **steel, and galvanized steel**. When the coil is applied to a magnetic material, the pipe becomes a shield and prevents the wave energy from entering the fluid path. The TWT Reaction Chambers provide an easily installed section of non-magnetic pipe to provide the proper pipe material for the Deposit Control System to work as designed. The TWT Reaction Chambers are fully sealed, protecting their two layers of factory-wrapped coil. The Stainless Steel Reaction Chambers are designed and manufactured to meet the highest quality specifications.

All TWT® products & systems come with easy to follow application and installation instructions

## CLEANER WATER IS HEALTHIER WATER! CHEMICAL-FREE



# Triangular Wave Technologies, Inc. (TWT®)

FILTRATION • TWT® PATENTED DEPOSIT CONTROL TECHNOLOGY • UV DISINFECTION & PURIFICATION

## 1. Filtration:

Filters are designed to trap various kinds of debris, dirt and organic particles that will otherwise enter your equipment and/or plumbing system, restrict your water flow and create a breeding ground for bacteria. Filtration is the first line of defense for residential, commercial, industrial facilities, where the source of water may be ponds, wells or streams that have high exposure to contamination from airborne pollutants, surface run-off, agricultural or industrial waste or similar dangers. The first step in achieving clean water is to install a filtration device that effectively removes particulate matter and similar debris. Filtration is an important step in water treatment, especially for water intended for human consumption. Filtration systems provide a bacteriostatic environment and are designed to remove, volatile organic chemicals, hydrogen sulfide and sulfur, herbicides, pesticides, chemical fertilizer residues, trihalomethanes and many other pollutants. The filtration units utilized in TWT systems are comprised of several filter types and media that remove harmful chemicals, metals, and toxins from the water as it passes through these layers. Filters used in staged filter housings are configured as illustrated on system trade ads. If needed other filter mediums and filters used in system can be determined by a water quality analysis. If fluid conditions require additional micronic particle trapping for enhanced results, filters are available in various micronic sizes providing flexibility & adaptability to meet the needs of all fluid conditions & applications.



## 2. Deposit Control (Chemical-Free)

### TWT® Patented Deposit Control Technology

The basic component in the TWT systems is the deposit controller. It is comprised of a microprocessor, solenoid coil wrap and/or a reaction chamber. The microprocessor is a patented controller that functions like a computer to relay a continuous electrical power supply to the solenoid coil and/or reaction chamber. The reaction chamber is plumbed into the main water in-take line and/or just before each piece of vital processing equipment, and provides a factory wrapped wire coil forming a solenoid. The solenoid conveys the triangular wave signal at the appropriate power level (as allowed by the model chosen) to the water passing through the chamber. This signal constantly changes the polarity, frequency, and amplitude of the current entering the water. This triangular wave treatment produces several benefits. It increases the capability of the water to hydrate scale ions and other colloidal particles. In effect, the surface charge of the hydrogen molecules is enhanced and the water is made "wetter". This "hydrated" water can dissolve unwanted particles, suspend them in solution, and allow them to be easily filtered out or flushed from the system. Accordingly, the mineral and biological particles that cause scale, deposits, and corrosion are dissolved and washed away.



This means that the breeding environments for bacteria, such as bio-film and corrosion, are eliminated. The agitation created in the reaction chamber also disrupts the conditions essential for the normal reproduction of bacteria and they die, thus allowing them to be harmlessly flushed out of the system. If left untreated, scale build-up inside the reaction chamber and on the quartz sleeve containing the UV lamps may rapidly diminish the UV disinfection effectiveness by reducing the amount of UV light which is absorbed into the water stream. The TWT Deposit Control System will further condition the filtered water stream so as to prevent this scale-build-up inside the UV reaction chamber, helping to maintain maximum UV life cycle and penetration into the water stream.

## 3. Disinfection /Purification:

### Ultra-Violet:



The UV disinfection technology used in the system to provide safe, potable drinking water, free of disease-causing pathogens. As water passes through the UV chamber, UV light will attack and render harmless any bacterial, viral or spore contamination present in the treated water. "High intensity UV light destroys these contaminants with a 99.9% kill rate" The output water is thus disinfected and offers exceptionally high quality for human consumption.

## 4. TWT® Point-of-Use Potable Water Treatment & Conditioning System

### Filtration • Patented Deposit Control Technology UV Disinfection & Purification

### COMBINED FOR MAXIMUM EFFECTIVENESS – THE COMPETITIVE EDGE!

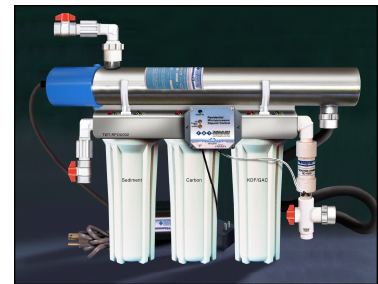

### TWT® technologically advanced method for water treatment. Triangular Wave Technologies, Inc. All-In-One fluid management systems, the ultimate in water treatment & conditioning

TWT® systems are factory assembled, applying all of the needed elements for maximum fluid protection, management, and peace of mind in one simple packaged solution. TWT® Filtration, Microprocessor Deposit Controller, Reaction Chamber, and UV Disinfection units are combined to provide a start-to-finish answer to simplified prevention, treatment and management of water line contamination dangers. *The TWT All-In-One Fluid management water disinfection/purification systems are unique, compact, self-contained units for the treatment of water.*

TWT, Inc. offers a full range of products & systems designed to address fluid problems wherever fluid flows. From patented deposit control technology to pre and post filtration needs, ionization, disinfection, and ultraviolet purification treatment and conditioning. Components and sub-systems chosen from across the range of treatment methods can be combined in different configurations to provide custom solutions specific to any industry, site or application. TWT has the versatile, efficient, cost-effective methods to solve your fluid management problems end to end.

## NO MATTER HOW TOUGH THE JOB... TWT® IS THE SOLUTION

For additional information: Visit Triangular Wave Technologies, Inc. Comprehensive Website. The Valuable Technical Resource For All Involved In Water And Fluid Management. [www.Triangularwave.com](http://www.Triangularwave.com)

